

SAVE THESE IMPORTANT SAFETY INSTRUCTIONS



This manual contains important safety, operating, and installation instructions – read before using charger.

Battery Safety Information

Warning: Use charger only on battery systems with an algorithm selected that is appropriate to the specific battery type. Other usage may cause personal injury and damage. Lead acid batteries may generate explosive hydrogen gas during normal operation. Keep sparks, flames, and smoking materials away from batteries. Provide adequate ventilation during charging. Never charge a frozen battery. Study all battery manufacturers' specific precautions such as recommended rates of charge and removing or not removing cell caps while charging.

Electrical Safety Information

Danger: Risk of electric shock. Connect charger power cord to an outlet that has been properly installed and grounded in accordance with all local codes and ordinances. A grounded outlet is required to reduce risk of electric shock – do not use ground adapters or modify plug. Do not touch uninsulated portion of output connector or uninsulated battery terminal. Disconnect the AC supply before making or breaking the connections to the battery while charging. Do not open or disassemble charger. Do not operate charger if the AC supply cord is damaged or if the charger has received a sharp blow, been dropped, or otherwise damaged in any way – refer all repair work to qualified personnel. Not for use by children.

Operating Instructions

1. Always connect the charger to a **GROUND**ED outlet. When using an extension cord, avoid excessive voltage drops by using a grounded, 3-wire, 12-AWG cord no longer than 30m (100').
2. **AVOID** connecting a QuiQ charger and another device to a single 15A/20A circuit or the circuit may become overloaded.
3. Charger 10-LED Display

LED indications following "Power-On Self Test":

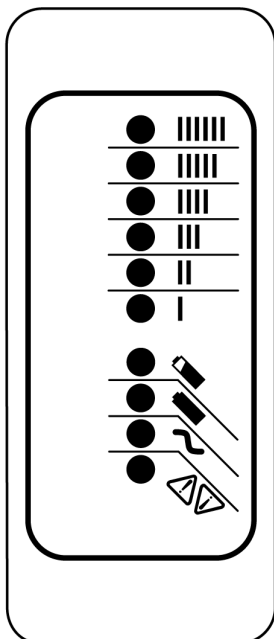

Ammeter (Amber)		Solid:	Displays approximate scale of current output during bulk phase.
		Flashing:	High internal charger temperature. Current output reduced.
			Also displays algorithm #1-6 for 11 seconds if no battery is connected.
80% Charge (Amber)		Solid:	Bulk charge phase complete, 80% charged. In Absorption phase.
		Flashing:	With no battery connected, indicates algorithm # selected by number of flashes.
100% Charge (Green)		Solid:	Charging complete. Charger in Maintenance Mode.
		Flashing:	Absorption phase complete. In Finish phase
AC On (Amber)		Solid:	AC Power good
		Flashing:	Low AC Voltage, check voltage and extension cord length (max 100', 12-AWG).
Fault (Red)		Flashing:	Charger error. Reset charger power and refer to Troubleshooting below.

INFORMATIONS IMPORTANTES DE SÉCURITÉ

Conserver ces instructions. Ce manuel contient des instructions importantes concernant la sécurité et le fonctionnement.

Information de Sécurité de la Batterie

Attention: Utiliser le chargeur seulement sur les batteries avec un algorithme approprié au type spécifique de batterie. D'autres types de batteries pourraient éclater et causer des blessures ou dommages. Les batteries peuvent produire des gaz explosifs en service normal. Ne jamais fumer près de la batterie et éviter toute étincelle ou flamme nue à proximité de ces derniers. Fournir la bonne ventilation lors du chargement. Ne jamais charger une batterie gelée. Prendre connaissance des mesures de précaution spécifiées par le fabricant de la batterie, p. ex., vérifier s'il faut enlever les bouchons des cellules lors du chargement de la batterie, et les taux de chargement recommandés.



Information de Sécurité Électrique

Danger: Risque de chocs électriques. Ne pas toucher les parties non isolées du connecteur de sortie ou les bornes non isolées de la batterie. Toujours connecter le chargeur à une prise de courant mise à la terre. Ne pas ouvrir ni désassembler le chargeur – référer toute réparations aux personnes qualifiés. Pas à l'usage des enfants.

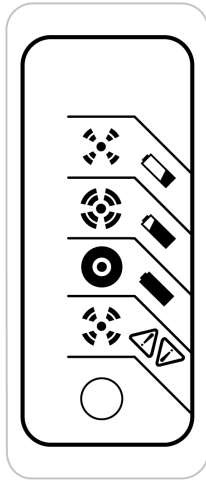
4. Optional Charger Single-LED Display (internal or external)



LED indications following “Power-On Self Test”:







Green		Solid: Charging complete. Charger in Maintenance Mode.
		Flashing: <i>Short:</i> <80% Charge. <i>Long:</i> >80% Charge. <i>When battery is not connected:</i> Algorithm Number display.
Amber		Flashing: Reduced Power Mode: Low AC Voltage or High internal charger temperature.
Red		Flashing: Charger error. Reset charger power and refer to Troubleshooting below.

Maintenance Instructions

1. For flooded lead-acid batteries, regularly check water levels of each battery cell after charging and add distilled water as required to level specified by battery manufacturer. Follow the maintenance and safety instructions recommended by the battery manufacturer.
2. Make sure charger connections to battery terminals are tight and clean.
3. Do not expose charger to oil, dirt, mud or direct heavy water spray when cleaning vehicle.

Troubleshooting Instructions

If a fault occurs, count the number of red flashes between pauses and refer to the table below:

Red Flashes	Cause	Solution
	Battery High Voltage	Check battery size and condition and reset charger (interrupt AC power for 15 seconds).
	Battery Low Voltage	Check battery size and condition and reset charger (interrupt AC power for 15 seconds).
	Charge Timeout caused by battery pack not reaching required voltage. Charger output was reduced due to high temperatures	Check connections. Operate charger at a lower ambient temperature.
	Check Battery: battery could not be trickle charged up to minimum voltage	Check for shorted or damaged cells.
	Over-Temperature: Charger shut down due to high internal temperature.	Ensure sufficient cooling air flow and reset charger (interrupt AC power for 15 seconds).
	Charger Internal Fault	Reset charger (interrupt AC power for 15 seconds). Return to qualified service depot if fault persists.

Installation Instructions



WARNING: The output of chargers with greater than 48V may pose an energy and/or shock hazard under normal use. These units must be installed in the host equipment in such a manner that the output cable and battery connections are only accessible with the use of a tool by qualified personnel.

Mounting:

- 1) Mount the charger with adequate ventilation. Ideally it will be mounted horizontally with airflow from below. If it will be mounted vertically, it is recommended that the DC-output cord be at the higher end of the charger.
- 2) Keep the charger free of oil, dirt, mud, or dust to keep the cooling fins operating as efficiently as possible.
- 3) Mount the charger by the mounting plate using appropriate fasteners. (ie. locking 1/4" or M6 bolts)
- 4) For UL2202 compliance, a 12AWG green bonding wire must be attached from the stud located on the charger (see Figure 1) to the vehicle frame.
- 5) Install such that risk of human contact with hot surfaces is reduced.
- 6) The charger's AC plug must be located at least 18" above the ground and the display visible to the user.

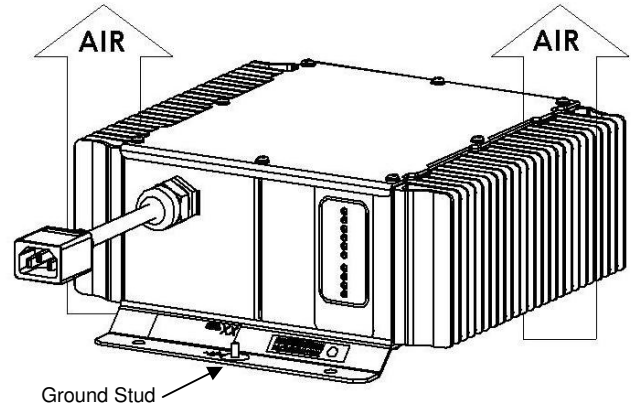

Figure 1: Charger Mounting

DC Battery Connection Procedure:

- 1) The green wire outputs battery voltage when the charger is not plugged into AC to provide an interlock function (see Figure 2).

If used, a user-supplied 1A fast-blow external fuse must be installed in-line to prevent damage.

Shorting or drawing more than 1A may damage charger and void the warranty.

- 2) Securely fasten the black ring terminal to the negative terminal ("-", or "NEG") of the battery pack.
- 3) Check that the correct charge algorithm is being used and change algorithm if necessary. Securely fasten the red ring terminal to the positive terminal ("+", or "POS") of the battery pack.

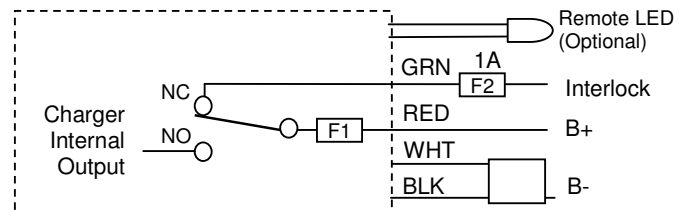

Figure 2: Charger Connections

Specifications

DC Output – see Operating Instructions

QuiQ Model: 912-	24xx	36xx	48xx	72xx
Voltage-nom (V)	24	36	48	72
Voltage-max (V)	33.6	50.4	67.2	100
Current-max (A)	25	21	18	12
Battery Type	Specific to selected algorithm			
Reverse Polarity	Electronic protection – auto-reset			
Short Circuit	Electronic current limit			

AC Input

All models	
Voltage-max (Vrms)	85 – 265
Frequency (Hz)	45 - 65
Current - max (Arms)	12A @ 104VAC (reduced by 20% < 104V)
Current – nom (Arms)	10A @ 120VAC / 5A @ 230VAC
AC Power Factor	>0.98 at nominal input current

Mechanical

All models	
Dimensions	28.0 x 24.5 x 11.0 cm (11 x 9.7 x 4.3")
Weight	<5 kg (11 lbs) w/ standard cord
Environmental	Enclosure: IP46
Operating Temperature	-30°C to +50°C (-22°F to 122°F), derated above 30°C, below 0°C
Storage Temperature	-40°C to +70°C (-40°F to 158°F)
AC input connector	IEC320/C14 (require ≥1.8m localized cord)
DC output connector	OEM specific w/ 12AWG wire

Operation

All models	
Battery Temperature Compensation	Automatic
Maintenance Mode	Auto-restart if V<2.1Vpc or 30 days elapse

Regulatory

Safety	
EN 60335-1/2-29	Safety of Appliances/ Battery Chargers
UL2202	EV Charging System Equipment
UL1564 2nd Ed.	Industrial Battery Charger
CSA-C22.2 No. 107.2	Battery Chargers- Industrial
Emissions	
FCC Part 15/ICES 003	Unintentional Radiators Class A
EN 55011	Radio disturbance characteristics (Class A)
EN 61000-3-2	Limits for harmonic current emissions
EN 61000-3-3	Limits of voltage fluctuations and flicker
Immunity	
EN 61000-4-2	Electrostatic discharge immunity
EN 61000-4-3	Radiated, radio-frequency, EMF immunity
EN 61000-4-4	Electrical fast transient/burst immunity
EN 61000-4-5	Surge immunity
EN 61000-4-6	Conducted Immunity
EN 61000-4-11	Voltage variations immunity

Programming Instructions

The QuiQ charger is pre-loaded with charge algorithms for up to 10 battery types (see Table 1).

Alg #	Battery Type
43	Discover AGM
37	Trojan T105 DV/DT CP - 42V pack w/ 48V charger
27	Crown CR-325
8	Concorde 10xAh AGM
7	J305 DV/DT CP
6	DEKA 8G31 Gel
5	Trojan 30/31XHS
4	US Battery USB2200
3	T105 DV/DT CP
1	Trojan T105



Table 1

Check Default Charge Algorithm

Enter Algorithm Display Mode:

- 1) Disconnect AC Power.
- 2) Remove positive lead from battery pack.
- 3) Apply AC power and the charger will display the algorithm number after the Power On Self Test:
 - a. All algorithms will display as a series of flashes of the '80%' LED.
 - b. Algorithms #1 - 6 will also be indicated by the Ammeter LEDs (see User's Guide).

Examples:

 = Algorithm # 7
 =
 Algorithm #43

- 4) Algorithm number display repeats for 11 seconds, then Algorithm Display Mode ends.
- 5) Remove AC Power and reconnect positive lead.

Change Default Charge Algorithm

- 1) Enter Algorithm Display Mode (as above).
- 2) While Algorithm Number is displayed (for 11 seconds), touch positive lead to the battery pack positive terminal for 3.0 seconds (+/- 0.5s).
- 3) Remove lead from battery pack. Algorithm Number will increment.
- 4) To increment the Algorithm Number again, repeat Steps 2 and 3 within 30 seconds.
- 5) Touch positive lead to positive terminal and hold until relay clicks (>10 seconds). The new default algorithm is now stored.
- 6) Remove AC Power and check default algorithm (as above)

Contact your original equipment manufacturer if your battery pack is not supported by the charge algorithms loaded in your charger.